

BASIC SWITCHES









Precision Snap Action Switches

FEATURES

- Snap action
- Plastic, flame resistant case
- Single, double and three pole circuits
- Eight types of terminations
- Long life
- 1000 V rms dielectric strength
- Current capacities from dry circuit to 40 amperes
- Military approved
- Environmentally sealed
- UL recognized
- Low movement differential and operating force types available
- Stacking and gang mounting capabilities

SELECTION AND SPECIFICATIONS TABLE

SERIES

Image	Series	Circuit	Electrical Rating Life	Terminals	Description	Characteristics					
						Catalog Number	Operating Force (Max.)	Release Force (Min.)	Pretravel (Max.)	Diff. Travel (Min.)	Over Travel (Min.)
	Series D	4 CKT Dbl. Brk.	15 amps, 125/250VAC, 60/400Hz 30VDC Resistive 10 amps, 125/250VAC, 60/400Hz 30VDC Inductive 100,000 operations mechanical life, 50,000 operations electrical life	End Solder Side Solder Side Solder End Solder Side Solder Side Solder	Standard Non-Simultaneous Break MS25348-1 MS25349-1 Reset Type	D4-4 D8-4 D8-9 D4-44 D8-44 D8-344	28+/-5 oz 2.18 lbs 1.25 lbs	3 oz. —	.060 in.	.028 ±.007 in.	.018 in.
	Series E-4 & EM	1 PDT	Operations, Min. 150,000 2.5 amps. 125/250VAC Res. & Ind. 100,000 5.0 amps. 125/250VAC Res. & Ind. 50,000 4.0 amps. 30VDC Resistive 50,000 2.5 amps. 30VDC Inductive	Solder Double Turret	Standard (Dust, Splash-proof)	E4-103 EM-4111	200 grams	40 grams	.020 in.	.003 in.	.007 in.
	Series EF	1 PDT	150,000 operations at 2.5 amps, 125/250VAC 100,000 operations at 5.0 amps, 125/250VAC 50,000 operations at 2.5 amps, 30VDC Inductive 50,000 operations at 4.0 amps, 30VDC Resistive	Wire Leads	Standard	EF-103	5-17 oz.	4 oz.	.050 in.	.004 in.	.003 in.
	Series G	2 CKT (1 PDT) Mom.	125/250VAC, 30 amps Resistive 125/250VAC, 20 amps Inductive 125/250VAC, 10 amps Motor 28VDC, 40 amps Resistive 28VDC, 30 amps Inductive 28VDC, 15 amps Motor 25,000 Operations Min.	Solder	MS25357-1	G3-44	50.75 oz	6 oz.	0.093 in.	.055 +/- .010 in.	.015 in.
	Series K	6 CKT 3 N.O. 3 N.C.	15 amps, 125/250VAC, 60/400 Hz, 15 Amp Ind., 30VDC Resistive, 15 amps 10 amps, 30VDC Inductive 50,000 operations	Side Solder	Standard U.L. Listed - 30A, 250VAC MS25356-1 MS25353-1, Reset Type	K3-4 K3-12 K3-44 K3-344	56 oz.	4 oz.	.060 in. .075 in.	.028 +/- .007 in. .036 in.	.015 in.
	Series S	2 CKT Dbl. Brk.	750,000 operations at 10 amps, 125VAC 10,000 operations at 1 amp, 125VAC pilot duty 200,000 operations at 10 amps, 30VDC res & ind U.L. Listed for 10 amps, 125/250VAC, 1/2 amp, 125VDC (1/2 hp, 125/250VAC) Military rated for 10 amps 125/250VAC, 30VDC Ind.	End Solder End Screw Side Solder	Standard	S1-4 S2-4 S3-4	12+/-3 oz.	4 oz.	.060 in.	.020 +/- .005in	.015in
		2 CKT Dbl. Brk.	50,000 minimum operation 125VAC, 10 amps Resistive & Inductive 30VDC, 10 amps Resistive & Inductive 125VAC, 6 amps motor 28VDC, 6 amps motor	End Solder End Screw	MS25342-1, .027 max move. diff. MS25344-1, .027 max move. diff.	S1-44 S2-44	1.25 lbs 12 +/-3 oz	4 oz.	.060 in.	0.027	.015 in.
		1 PNC Dbl brk. 1 PNO Dbl brk.	750,000 operations at 10 amps, 125VAC 10,000,000 oper. at 1 amp, 125VAC pilot duty 200,000 operations at 10 amps, 30VDC Inductive Military rated for 10 amps 125/250VAC, 30VDC	Side Solder End Screw Side Solder Side Solder	MS25343-1, .020+/- .005 move diff Standard .020 +/- .005 move. diff. Standard .010 +/- .004-.003 mv df U.L. Listed	S3-44 S2-25 S3-5 S3-6	19 oz. 15 oz. 15 oz. 15 oz.			+/- .020in	.015 in.

BASIC SWITCHES

Precision Snap Action Switches

APPROXIMATE DIMENSIONS

Terminal Styles (Other terminations available)

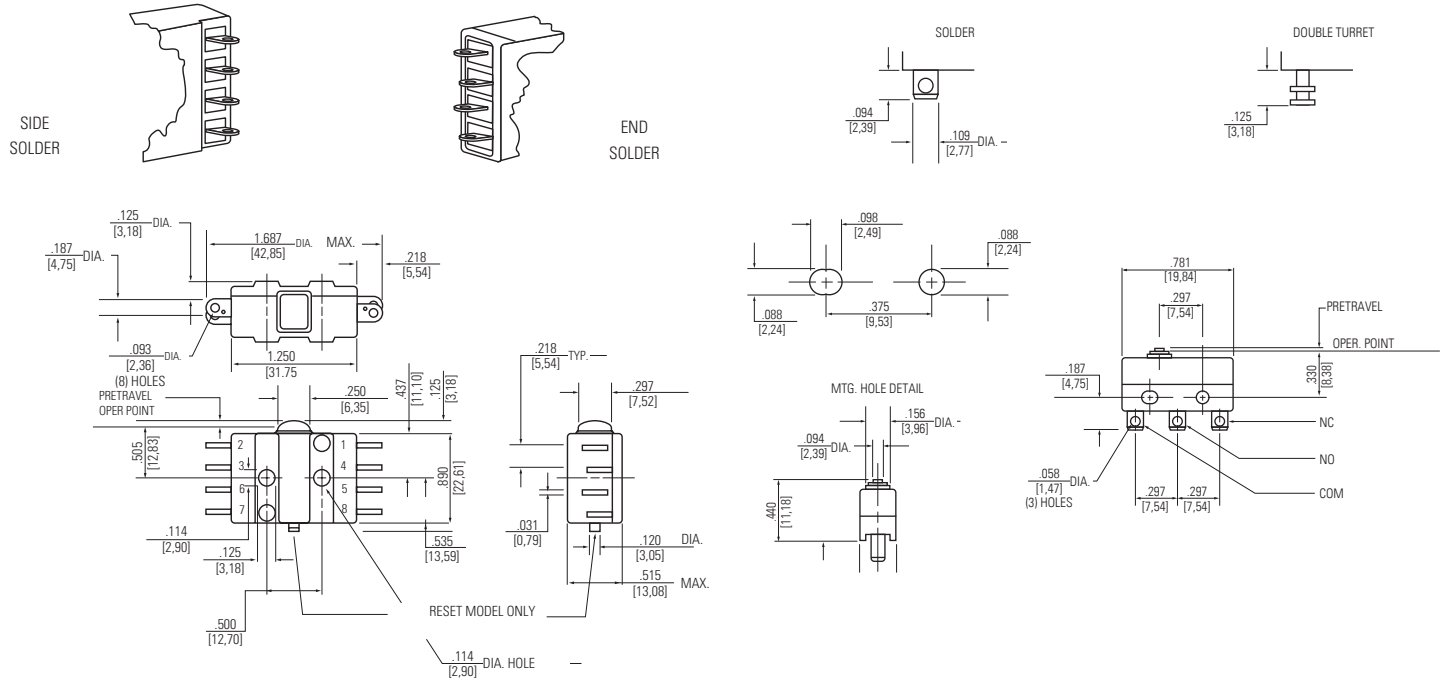

Series D

Series E4 and EM

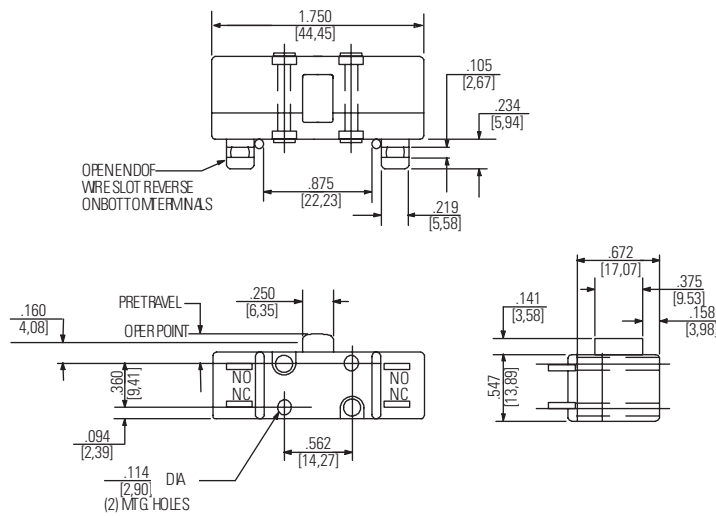

Series G

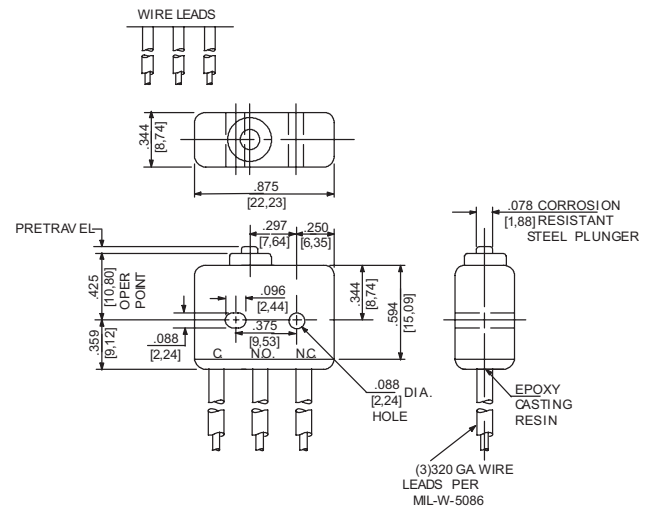

Series EF

STANDARD

0.00 = inches

[0,0] = mm

Dimensions for reference only.

BASIC SWITCHES

Precision Snap Action Switches

APPROXIMATE DIMENSIONS

Terminal Styles (Other terminations available)

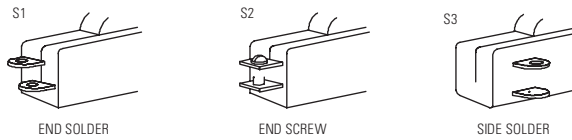

OTHER TERMINATIONS AVAILABLE

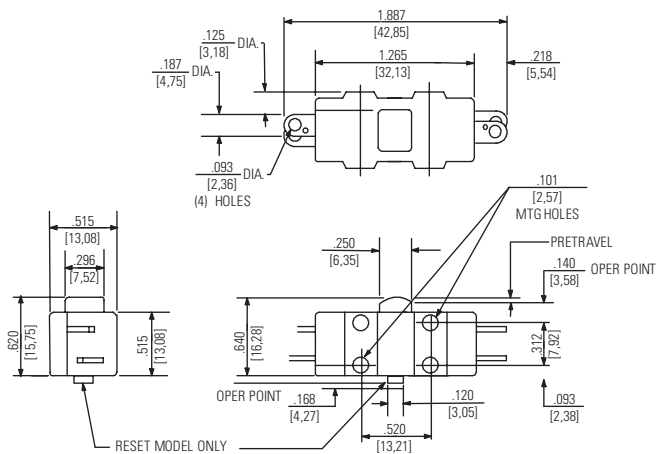

Series S

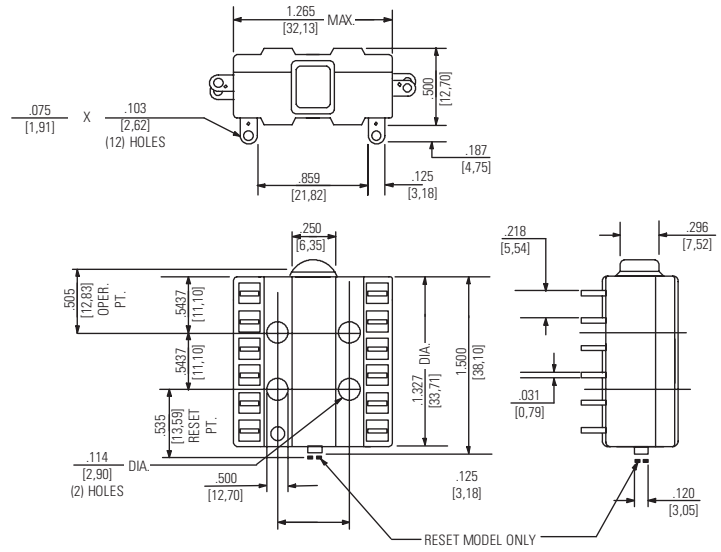

Series K

STANDARD
0.00 = inches
[0,0] = mm

Dimensions for reference only.